

DRO 100™

REFERENCE MANUAL

ACU-RITE®

Warranty

ACU-RITE Products and accessories are warranted against defects in material and workmanship for a period of three years from the date of purchase. ACU-RITE will, at its option and expense, repair or replace any part of the ACU-RITE product that fails to meet this warranty. This warranty covers both materials and factory labor. In addition, authorized ACU-RITE service representatives will provide service labor (field service) for a period of one year at no charge. Notice of the claimed defect must be received by ACU-RITE within the warranty period.

This warranty applies only to products and accessories installed and operated in accordance with this reference manual. ACU-RITE shall have no obligation, with respect to any defect or other condition caused in whole or part by the customer's incorrect use, improper maintenance, modification of the equipment, or by the repair or maintenance of the product by any person except those deemed qualified by ACU-RITE.

Responsibility for loss of operation or diminished performance due to conditions beyond ACU-RITE's control cannot be accepted by ACU-RITE.

The foregoing warranty obligations are in lieu of all expressed or implied warranties. ACU-RITE INCORPORATED shall not be liable under any circumstances for consequential damages.

30 Day Red Carpet Warranty

All ACU-RITE products are covered by a 30-day Red Carpet Warranty. If in the first 30 days this product fails for any reason, repack it in the original packing materials and contact your Authorized ACU-RITE Distributor for return procedures.

Introduction	1
A Tour of the Readout.....	1
Front and Back Views.....	1
Keypad	2
Displays.....	2
Power-On Position Recovery	3
Position-Trac	3
Readout Operations.....	4
Absolute and Incremental Displays.....	4
Absolute Display.....	4
Incremental Display	4
Radius/Diameter Display	5
Zeroing the Display	6
Absolute Zero	6
Incremental Zero.....	6
Setup	7
Display Resolution.....	7
Linear Error Compensation.....	8
Count Direction.....	9
Encoder Resolution	9
Radius/Diameter.....	9
Installation	10
Readout Specifications	13
Troubleshooting	14



This symbol alerts you to the fact that important information concerning the installation and operation of this readout has been included in this manual.

Keep these instructions in a secure place for future reference.

Introduction

ACU-RITE's DRO 100 readouts provide features for you to obtain increased efficiency and productivity from your manual machine tools. They are designed specifically for grinding applications, but they are also particularly useful for X-Y tables, height gages, and other applications.

A Tour of the Readout

Front and Back Views

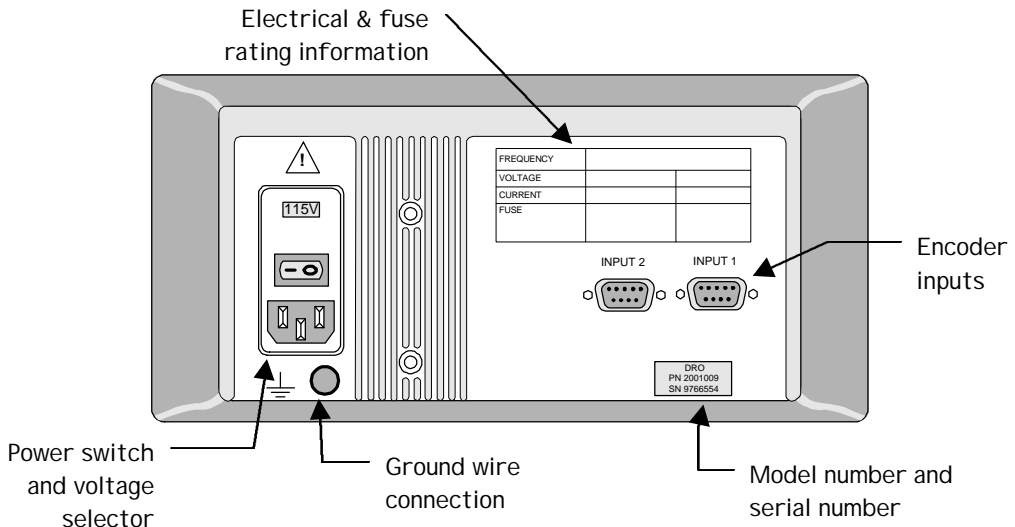
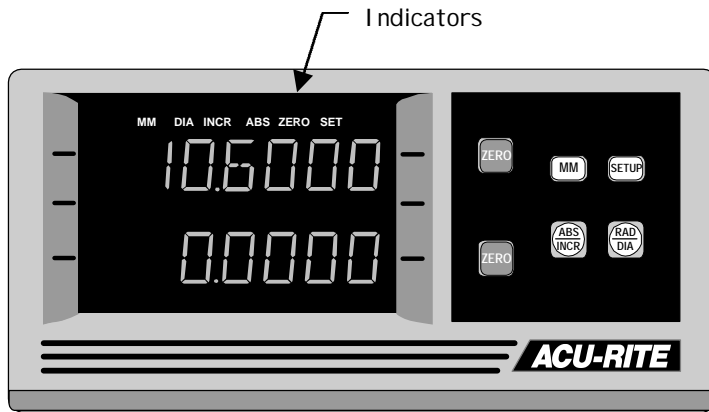

Keypad



Zero an axis display

English / metric conversion



System setup parameters



Selects absolute or incremental display



Selects radius or diameter display

Displays

At the top of the display window is a row of indicators. These tell you the current state of the readout.

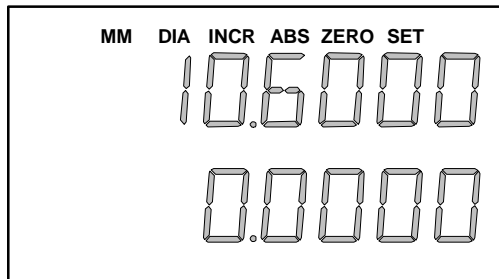
**MM**

Appears when you're positioning in metric, dark when you are positioning in inches.

ZERO SET

Lets you know when you are setting an absolute zero.

DIA

Tells you when an axis is displaying diameter.

INCR ABS

These tell you if the position display is incremental or absolute.

In addition to the lighted indicators along the top of the display, the top axis display will scroll longer messages that will help you step through some of the procedures.

Power-On Position Recovery

Position-Trac

Certain ACU-RITE encoders, such as the ENC 150, contain closely-spaced reference marks that enable the display to show the correct position after a power interruption. The readout will tell you when power has been lost, and will prompt you to move each axis until a reference mark is located. By traversing the reference marks once in each axis, you will re-establish the display position relative to the last known zero. The most you will ever have to move an axis is about one inch. You must move in the positive count direction. A flashing decimal point indicates that the last position has not been recalled.

If you use an encoder without Position-Trac, the procedure for recovering your position is slightly different. Reference marks on these encoders are about 8" apart. You must find a convenient reference mark and then use the same mark every time.

1. Move near the desired reference mark.
2. Press and hold the  key until the decimal point starts to flash.
3. Move slowly past the reference mark until the readout recalls its position. You must move in a positive direction.

Readout Operations

Absolute and Incremental Displays

Absolute Display

Shows the distance from your current position to *absolute zero*.

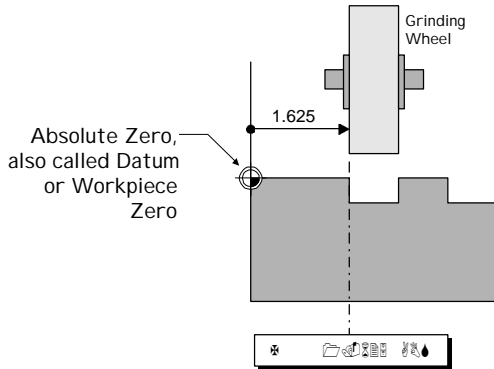

Incremental Display

Shows the distance from your current position to *incremental zero*. An incremental zero is set when you zero the incremental display.

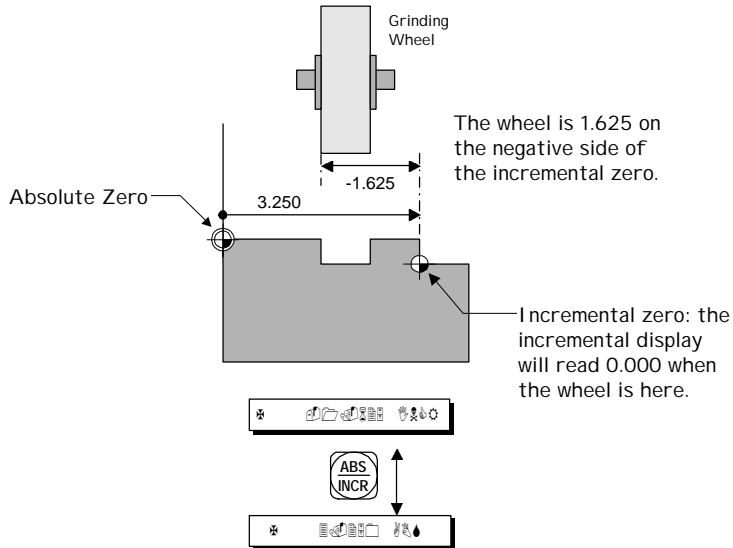

Radius/Diameter Display

Pressing the  key lets you view the part dimension either as a radius or as a diameter.

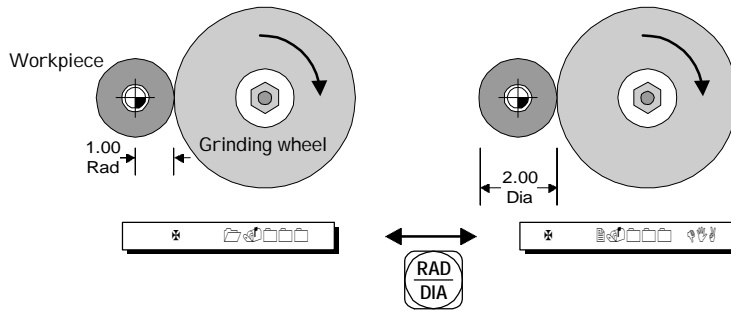

Zeroing the Display

Absolute Zero

On many prints, dimensions are measured from one or two surfaces of the part. By setting the readout's absolute display to zero at a well-chosen surface, you can use the part's dimensions directly from the print.

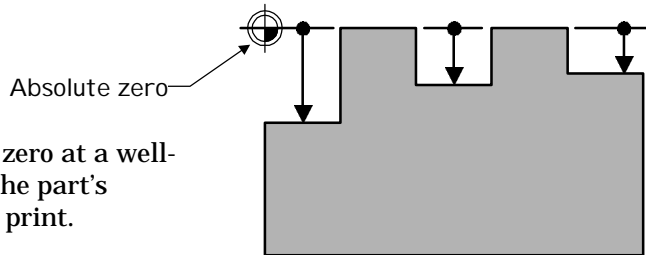

Setting Absolute Zero

1. Touch the wheel to the edge of the workpiece.

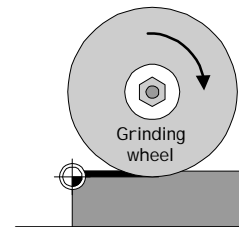

2. Make sure the absolute position is displayed.





3. Press the **ZERO** key of the appropriate axis.





Incremental Zero

From the incremental display, press the **ZERO** key. This sets the incremental current position.

Setup

The  key lets you change the system parameters. The keys you use to change setup parameters are different for one-axis and two-axis readouts. To move from one parameter to the next, press the upper  key (the  key for a single-axis readout). After the last parameter, the same key ends the setup process and saves any changes.

Some parameters may be set differently for each axis. For these parameters, the display will indicate the axis by number. For example, linear error compensation factors are indicated by LEC1 for the first axis and LEC2 for the second axis.

Some parameters have choices. Use the lower  key to cycle through these choices. If you have a single-axis readout, use the *only*  key whenever the lower  key is referred to.

Display Resolution

The display resolution will be the same as the encoder resolution. If the job tolerance is coarser than the encoder resolution (± 0.005 , for example), you can adjust the display resolution so you won't be tempted to waste time by machining to a finer resolution. Use the lower  key to cycle through all the possible choices. The choices available depend upon the resolution of your encoders.

Linear Error Compensation

Using the readout's linear error compensation feature, you can compensate for machine inaccuracies.

You will need a dial indicator and a measurement standard.

1. Position the standard near the center of the region to be compensated.
2. Press the lower **ZERO** key to start the auto calculation process. For a single-axis readout, press the **ZERO** key once to view the current compensation factor, and again to start the auto calculation process.
3. Enter one edge of the standard.

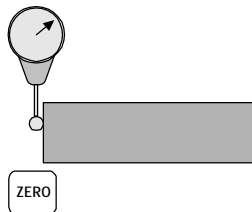

4. Enter the other edge of the standard.

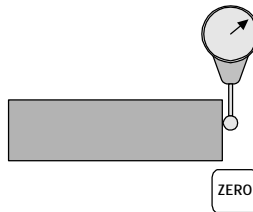

5. Move the axis until the display reads the actual size of the standard, including the probe diameter if necessary, then press the **ZERO** key.

If the display shows all dashes, refer to "Display Overflow Errors" on page 17.

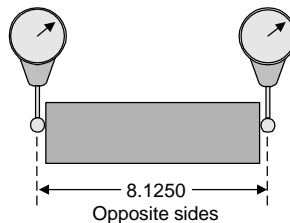

For a two axis readout, press the upper **ZERO** key for the next axis.



Count Direction

This determines which way is positive. Move each axis in the positive count direction. The display will show a 1 or a 2 depending on count direction. You can change the count direction by pressing the lower  key.

Encoder Resolution

Move each encoder until the readout senses and displays the resolution. You shouldn't have to move more than two inches. For encoders without Position-Trac, press the lower  key repeatedly until you see the resolution you want.

Radius/Diameter

You can set either axis (or both axes) to display diameter readings when the  key is pressed. Use the lower  key to allow (display = 1) or disallow (display = 0) diameter display.

Installation

IMPORTANT

Before installing the DRO 100 readout, record the serial number on the warranty card and return it to ACU-RITE INCORPORATED. The serial number label is located on the back of the readout.

Selecting a Location

Selecting a location for the readout is an important consideration for proper installation. Keep the following points in mind when selecting a safe and convenient location:

- The readout should be within reach of the operator for easy access to the keypad.
- The readout should be approximately at eye level.
- Avoid moving components or tools and minimize coolant splash or spray.
- The operating environment must be within the temperature range of 0° to 40° C (32° to 104°F) with a non-condensing relative humidity of 25% to 85%.

Proper Mounting

ACU-RITE has developed special mounting kits for the readout which address the most common mounting requirements. Mounting kits include:

- Column and base machine mountings
- Hardware and mounting instructions

These kits are available from your factory authorized ACU-RITE Distributor or OEM/OEI.

If you fabricate a support device for the readout, it should be large enough and strong enough to accommodate the readout. It must also be stiff enough to minimize any vibration induced by machinery on the shop floor.

Connecting the Encoders

Insert the connector from each encoder into the mating connector on the back of the readout. Fasten it with a small screwdriver.

Encoder input 1 will be displayed in the readout's top display and input 2, if any, in the bottom display.

Provide enough slack in the encoder cables to allow for full travel of all machine axes. Check that machine movements will not pinch the cables. Use the cable tie-down hardware kits supplied with the encoders to fasten the cables neatly to the machine.

Connecting a Ground Wire

Connect a ground wire from the terminal on the back of the readout to the machine. The machine should also be connected to a solid earth ground. If not, be sure that the readout is.

Checking Voltage and Connecting Power



CAUTION

Connecting the readout to a power source outside of the acceptable range, or making an inappropriate setting with the voltage selector, may damage the readout, the encoders, or both.

Check that the voltage available at the power source is within specification before connecting it to the readout. If required, set the voltage selector to match the line voltage.

1. Remove the caution label from the input module, and use a thin-blade screwdriver in the slot at the top of the power input module to open the module cover.

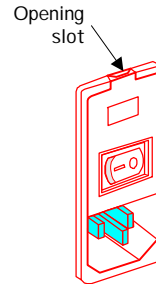

2. Pull the selection block out.

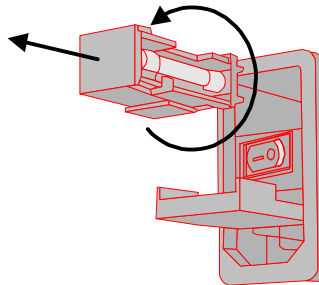

3. Remove the fuse, move the shorting bar to the other side, install the proper fuse, and push the block back into place.

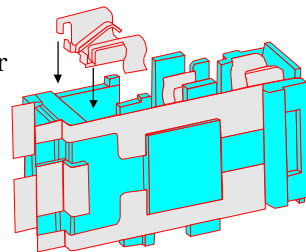

4. Close and snap the cover shut.

The voltage setting will show through the window in the voltage selection cover. Connect the readout to the power source using the power cord supplied

Readout Specifications

Characteristic	Specification
Operating conditions	0° to 40°C (32° to 104°F) 25% to 85% relative humidity (non-condensing)
Storage conditions	-40° to 60°C (-40° to 140°F) 25% to 95% relative humidity (non-condensing)
Input requirements	Voltage: 115VAC or 230VAC (+/-20%), single phase Frequency: 47-63 Hz Current: 150ma @115V, 75ma @230V
Fuse	115V operation: ½ A, 250V, 3AG, Slo-blo 230V operation: ¼ A, 250V, 3AG, Slo-blo
Encoder input	Position signals: channels A & B TTL square wave signal in quadrature (90° nominal phase relationship) Maximum input rate: 50 kHz Reference signal: TTL square wave
Size	9.875"W x 4.625"D x 4.75H"
Weight	7 lbs.
Mounting	Bottom: two ¼ -20 threaded inserts
FCC compliance	Class A

Troubleshooting

This section is intended to provide you with some basic troubleshooting assistance with your readout system. If you cannot correct the problem after following these instructions, contact your authorized ACU-RITE distributor or OEM/OEI for repair or replacement procedures.

No Operation

NOTICE

If you turn power off, you must wait at least 5 seconds before turning it back on, or the readout may not power up. This is because the power supply, in order to withstand brief power outages and brownouts, requires several seconds to reset itself.

If the readout display will not operate, check the following conditions:

- **Check AC power source.** If the readout cannot be powered up, confirm that line voltage is present at the source and that the line voltage meets the required specifications.
- **Check power cord.** Remove the power cord at the electrical input module on the back of the readout. Determine if line voltage is present at this end of the cord.
- **Check fuse.** With the power cord removed, use a thin straight-blade screwdriver to remove the cover of the electrical input module. Refer to page 12. Slide out the fuse holder and check the fuse. If necessary, replace it. Replace the input module cover by snapping it back into place, and reconnect the power cord.



CAUTION

Replace fuses only with the specified type. Using incorrect fuses can present a safety hazard. The readout may also be permanently damaged. Refer to the Readout Specification chart on page 13 for the correct fuse.

Incorrect Operation

If system positioning does not seem to be repeatable, the problem could be with the machine tool or with the readout system.

- **Check the machine tool.** Check that the table is not locked. Check the gib adjustments. Check spindle run-out.
- **Check linear encoders.** Check each encoder and reading head for proper installation. Ensure that the mounting brackets are secure.

If the system seems to be displaying incorrect positions, check the following items.

- **Verify grinding wheel or tool.** Check the grinding wheel or tool for wear.
- **Verify linear error compensation.** Make sure that the factors used for linear error compensation are correct.

Power-On Self Test

There are four tests performed when power is applied to the readout. You will not notice these tests unless a problem is found, in which case a message will scroll across the display.

Keypad—a key was detected stuck down. The message will display what *row* (x) and *column* (y) the stuck key is in:

KEY STUCK – RxCy – PRESS CLEAR

Parameter memory—some of the system setup parameters are not valid. You may be able to check and reset these settings, but it's possible they will be lost again. The readout should be serviced as soon as possible.

MEMORY FAILURE [1] – PRESS CLEAR



CAUTION

Some working settings are not valid. Proceed with caution.

Working memory—the memory used by the readout for calculations is faulty. While it may be possible to use the readout, its position display and other information will not be reliable.

MEMORY FAILURE [2] – PRESS CLEAR



CAUTION

The readout cannot be relied on for correct operation if any memory failure is indicated. The readout should be serviced immediately.

Program memory—the memory used to store the software is faulty. While it may be possible to operate the readout, some functions will not work properly and incorrect information may be displayed.

MEMORY FAILURE [3] – PRESS CLEAR





CAUTION

The readout cannot be relied on for correct operation if any memory failure is indicated. The readout should be serviced immediately.



Internal Testing

Several internal tests may be performed to ensure that the readout is functioning properly. Tests are available for the internal memory, the keypad, and the display. In addition, the testing procedure reports the software version of the readout.

Begin the internal testing by holding down the  key for about 2 seconds. The software version will appear in the display

Keypad test Begin by pressing the (upper)  key, then press each key (except the  key) in turn to verify that it is functioning properly. When a key is pressed, the display activates a “plus sign” indicator and increments a count. When you release the key, the plus sign disappears.

Display test Begin by pressing the  key. All indicators in all displays will light. Visually check each portion of each display to ensure that they are functioning properly.

Press  again to test the display electronics. All decimal points on all displays will light momentarily, then each segment of all displays will light in turn. Press  again, and each digit of all displays will light, one digit at a time, starting with the leftmost digit and moving to the right.

Exit the diagnostics by pressing the  key.

Other Errors

The readout includes built-in test and error-checking circuitry. This circuitry identifies errors that occur, and reports the problem to the operator. Errors are reported by scrolling messages in the display.

Loss of power is indicated by the “Power was off” message. Loss of power means that power to the readout has been interrupted. Since power to the encoders has also been interrupted, positioning information may no longer be accurate. Press any key to clear the error message. All display measurements will be zeroed. Refer to page 3 for information about position recovery.

Counting errors are indicated by the “Scale miscount” message, telling you in which axis the miscount occurred. Counting errors result from distorted electrical signals from an encoder. These signals can be a result of an encoder malfunction, misalignment, mounting problems, or electrical interference. Press any key to clear the error message. The axis display (for both absolute and incremental measurements) will be zeroed. Follow these steps to determine if your difficulties are associated with the readout or with the encoder.

- Ensure that the linear encoder connectors are correctly seated.
- Swap linear encoder cables at the readout to see if the problem still appears in the same display.
- If the problem remains in the same display, the readout is in error.
- If the problem follows the connection change, the linear encoder may be in error. Refer to the Checking the Linear Encoders section of your encoder reference manual.





Display overflow errors are indicated by dashes in all digits in an axis display. A numeric overflow occurs when the intended measurement is too large for the eight-digit display. Clear the error by returning the machine axis into an area

where measurements can again be displayed, selecting a lower display resolution, or zeroing the display.

This error may also occur when using the automatic compensation routine while setting the LEC parameter. An error indicates that the calculated compensation factor was outside the acceptable range of -9999 to +9999, and usually is the result of incorrectly entering data. Clear the error and return to the beginning of the linear error compensation routine. Refer to page 8.

Data Logging

The readout collects information about itself while it is being used. This information is stored in memory for review at a later time.

Press and hold the  key until the software version is displayed. Then press the  and  keys simultaneously. Use the  key to cycle through the following information.

Power on time—displayed in decimal hours.

Scale travel distance—the travel distance for each axis is scrolled one after the other.

Last 3 errors—the most recent three errors are remembered and messages for the errors are scrolled one after the other.

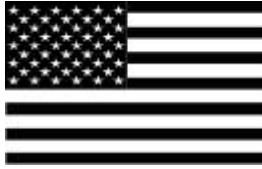

**ACU-RITE Readout Systems are
manufactured in the USA**

ACU-RITE IS AN
ISO 9001
CERTIFIED
MANUFACTURER

ACU-RITE[®]

ACU-RITE INCORPORATED
ONE PRECISION WAY
MASON INDUSTRIAL PARK
JAMESTOWN, NEW YORK 14701